

Certikin
international ltd

INLET & RETURN FITTINGS

FEATURES

- Available in ABS as standard
- Chrome plated brass finish for concrete pool fittings
- Eyeball directional inlet with safety grille
- Vacuum fittings supplied with removable plug
- For liner installations a watertight clamp plate and cover plate hide the fixing screws
- All fittings have interchangeable front faces
- Fittings available for all methods of pool construction
- All liner inlets are through wall fittings



Certikin's range of top quality swimming equipment is designed for all types of swimming pools. This leaflet shows just one of the many product ranges available from your Certikin pool equipment supplier.

By using only Certikin equipment you will ensure ease of supply now and in the future.

INLET & RETURN FITTINGS

Adjustable Inlets for concrete pools

CK/HD 5015/502

Manufactured in chrome plated brass with stainless steel plates (CK) or in plastic (HD) Certikin adjustable inlets allow easy control of flow rates into the pool. The CK5015/502 can be installed in the pool floor for increased flow – particularly suitable for level deck pools.

Directional Inlets

HD53 Eyeball Inlet

Direction of flow into pool is easily controlled by adjusting the “Eyeball” which features a safety grille to prevent children’s prying fingers. By adjusting the direction of flow, heating and chemical dispersion is made easier

Vacuum Points

HD20 (Concrete or liner) CK20/202 (Concrete only)

For use where an automatic pool cleaner or vacuum hose (use a Certikin HD23 hose-to-wall connector) is to be fitted. The vacuum point can be plumbed in for use either as a suction point or return fitting (depending on type of cleaner to be used). All types of vacuum fittings are supplied with a removable plug.

HD54

Sited low down on the pool wall and used as a low level suction point. Also used in conjunction with the HD108 Automatic Level Controller.

See SPATA guides for recommended suction velocities.

Inlets & Returns

Notice: Available for all types of pool construction; when ordering please use the appropriate suffix as listed below:

C – for concrete pools

L – for liner pools

PL – for prefabricated pools with liners

Both the liner types include a watertight clamp plate and a cover plate which hides the fixing screws.

Some of the range are available in a choice of plastic or chrome plated brass – please use the prefix as listed below:

HD – plastic

CK – chrome plated brass (for concrete pools only)

Code	Flow Max
HD5015	5m ³ /Hr
HD502	9m ³ /Hr
CK5015	5m ³ /Hr
CK502	9m ³ /Hr
HD53C	5m ³ /Hr
HD53L	5m ³ /Hr
HD53PL	5m ³ /Hr
HD54C	5m ³ /Hr
HD54L	5m ³ /Hr
HD54PL	5m ³ /Hr
CK20	5m ³ /Hr
CK202	9m ³ /Hr
HD20	5m ³ /Hr
HD20L	5m ³ /Hr
HD20PL	5m ³ /Hr



EYEBALL INLET

HD53 C

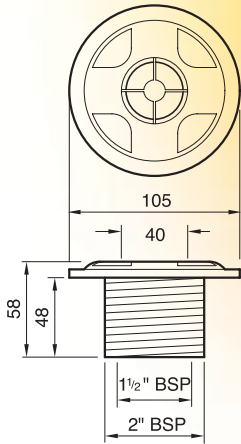

SUCTION GRILLE

HD54 C

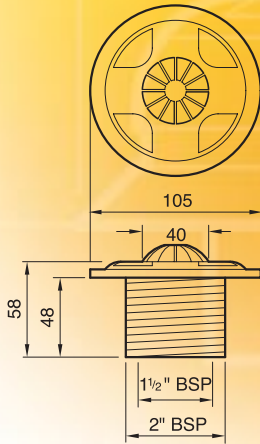

VACUUM POINT

HD20

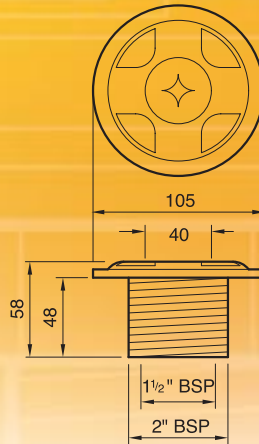

HD55

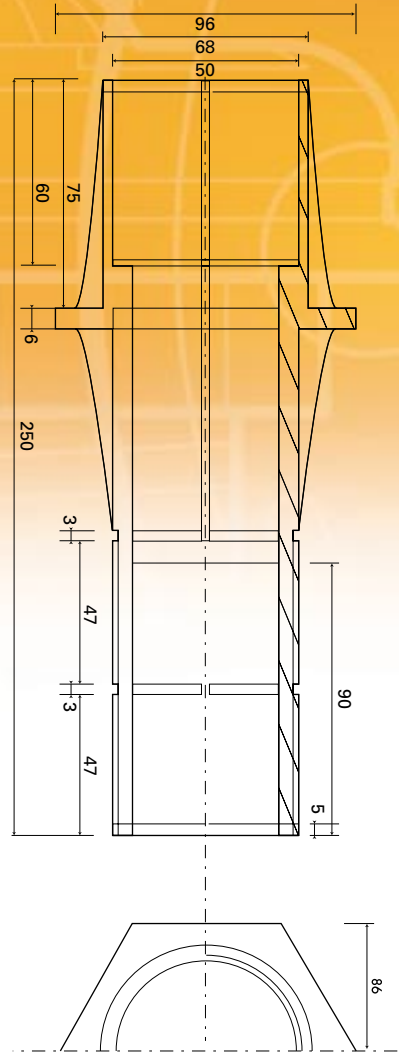

HD53 L

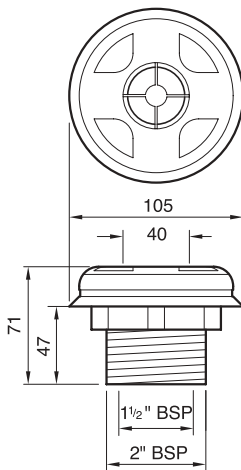

HD54 L

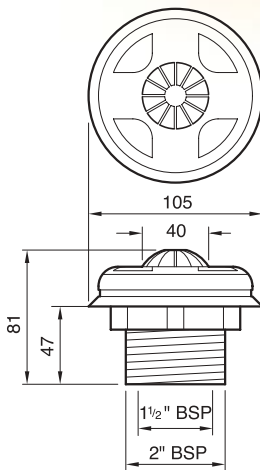

HD20 L

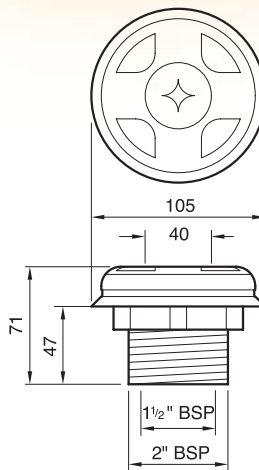

CK202

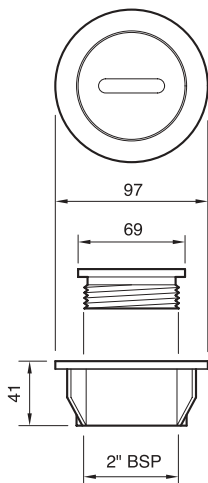

CK20

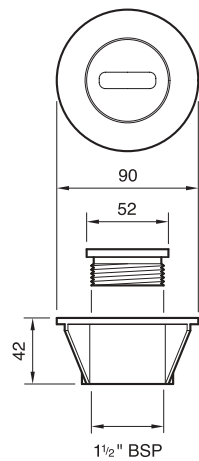

HD502

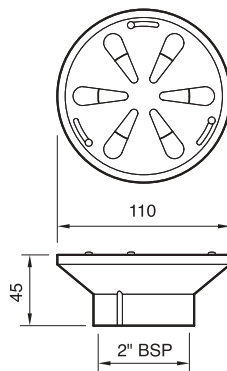

CK5015

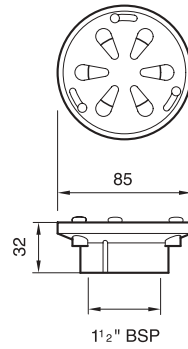

SPC493

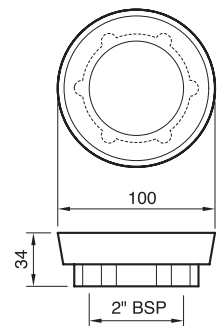

If you should require further technical information please do not hesitate to contact us.

