

# SEAMAID LED (UK) - INSTALLATION GUIDE



**WHITE 18 W Universal LED Flat Light )**

**WHITE 24 W Universal LED Flat Light (with remote control)**

**RGB 18 W Universal LED Flat Light (with remote control)**

## Warning



Failure to comply with the instructions given by the manufacturer in this manual regarding installation, operational start up and maintenance of the product exonerates the manufacturer or the distributor from any liability for damages affecting persons, the concerned product or the other installations, and shall void the guarantee.

Installation, repair and maintenance operations must always be carried out with the product disconnected from the electricity supply

The product should not be powered by a voltage of more than 12 Volts

Persons installing the product must be suitably qualified and be familiar with the BS 7671:2008 IEE Wiring Regulations 17th Edition: SPECIAL WIRING FOR SWIMMING POOLS

Conditions of use, storage and shipment :-20°C / + 65°C

It is recommended to install a protection device against excess voltage coming from the main electric supply to prevent irreversible damage to the product..

**GUARANTEE** This LED bulb is guaranteed 24 months against any materials and/or manufacture defect (electronic components) from the date of delivery. (Please keep the purchase invoice/receipt)

The bulb is not guaranteed against problems coming from excessive voltage, electrical overload, electric short-circuit or excessive over tightening of light housing.

The product is not guaranteed against electrical voltage surge coming from the external power supply. (In this case, refer to the house insurance coverage)

This guarantee is conditioned with the strict respect of these instructions of assembly and maintenance. Under this guarantee, the only obligation falling on the manufacturer or distributor will be the free replacement or repair of the product or the element found defective by their after sale services. All the other expenses will be the responsibility of the purchaser. For any replacement or repair, the product must be subjected to an inspection to the after-sales service of the manufacturer or distributor.

Any defects and deterioration caused by the fair wear and tear or defects resulting from a incorrect assembly or modification (unless by written agreement of the manufacturer) are excluded from guarantee.

The guarantee is limited to the original customer purchaser and is not assignable.

If a defect in materials becomes evident during normal use and service within two years, we will supply replacement parts free of charge, within a reasonable time, without transportation costs (limited to United Kingdom). The manufacturer/distributor/retailer will not be liable for consequential damages to your home or other equipment, loss of time, inconvenience or loss of use of the LED light.

# UK COMPONENTS

**Light** WHITE Universal LED Flat Light  
RGB Universal LED Flat Light

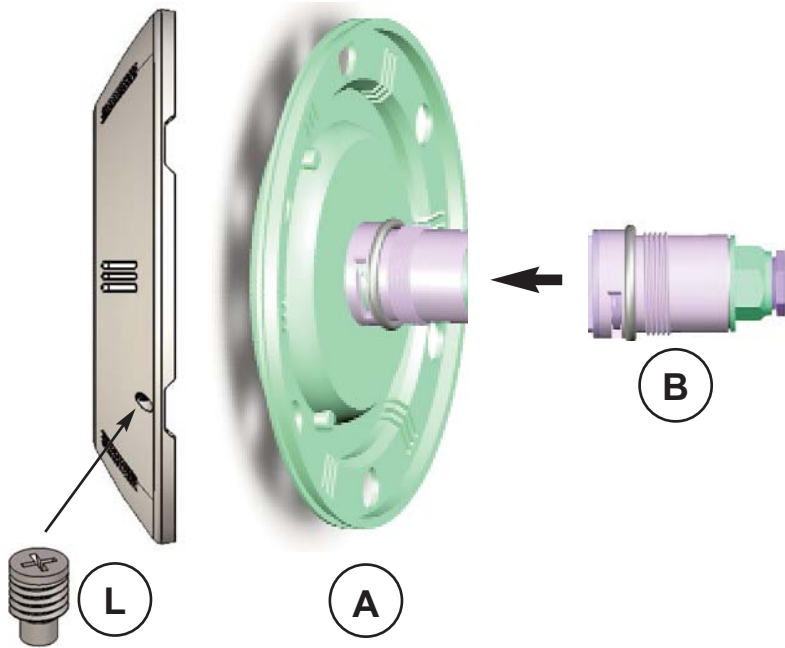

**Transformer**

1315-B LED 12v Transformer  
(will supply 5 lights)

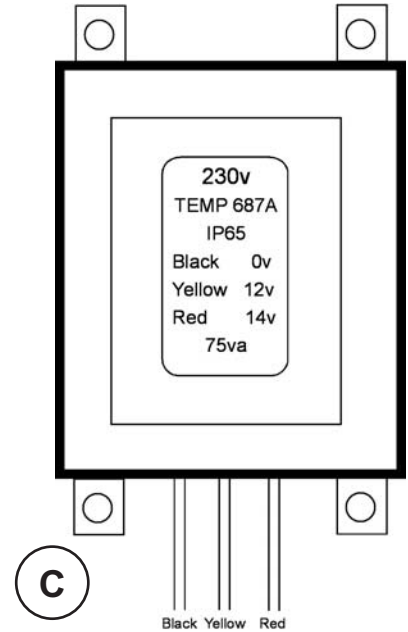

**Deck Box, Conduit & Wall Fitting Kit** Code1314-B

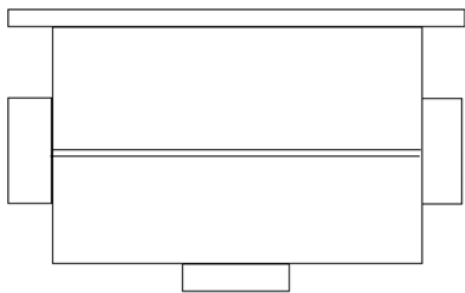

**D** Deck Box

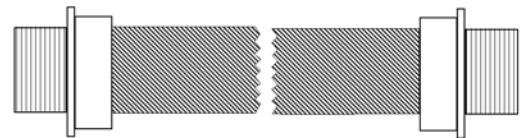

**G** Conduit 890mm

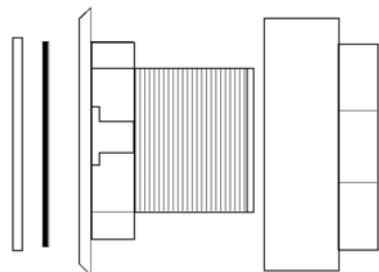

**E** Universal Wall Fitting  
(concrete/liner)



**H** Metric- Imperial Bush  
(may have been pre-glued by distributor).

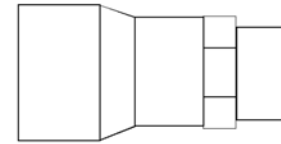

**I** 50mm MP-0.75 FT  
(Inlet Adaptor)



**F** 300mm x 1.5" ABS Pipe

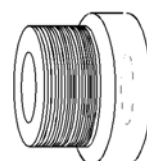

**J** 1.5" MT - 0.75 FT  
(Threaded Reducer for Conduit)

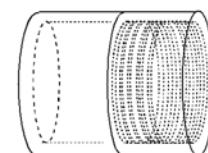

**K** 1.5" FP-FT

**INSTALLATION** - You will need the following components to install a complete light system. Universal LED Flat Light , LED 12v Transformer (will supply 5 lights), Deck Box, Conduit & Wall Fitting Kit.

**Important Notice - UK.** Use only the 1.5" outlet fitting supplied by Paramount Pool Products. The universal wall fitting **can be used for either** concrete or liner installation. **DO NOT USE** a standard inlet/outlet fitting from another supplier. Do not use in an above ground pool with flexible wall.

**STEP 1** Install Universal Wall Fitting (E) into desired wall structure along with the correct fitting components to enable the flexible Conduit (G) to attach to the Deck Box (D). **Make sure that adequate sealing methods are used i.e. PTFE / Glue to fix component parts together.** See diagram below.

**STEP 2** Secure Deck Box into pool surround and thread a draw cord through to wall fitting.

### Panel Pool

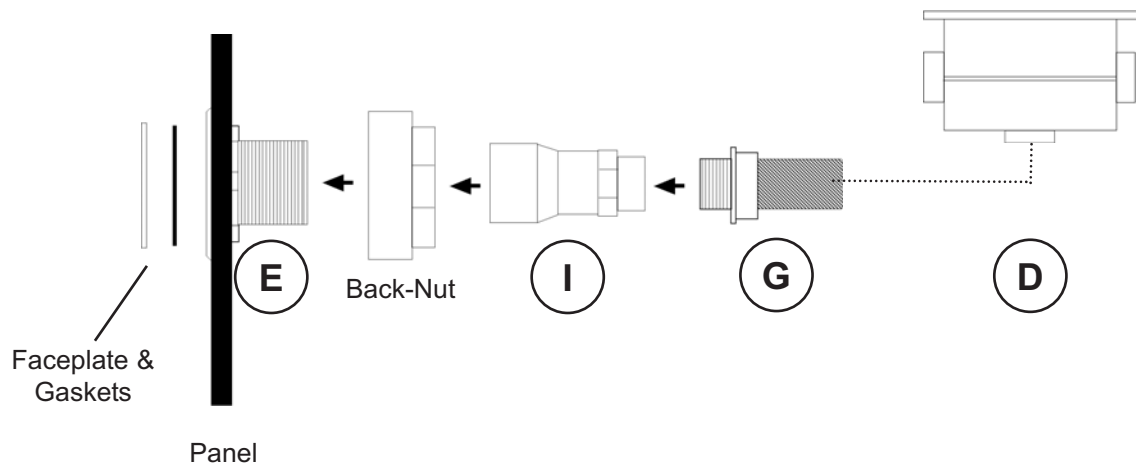

### Block & Liner

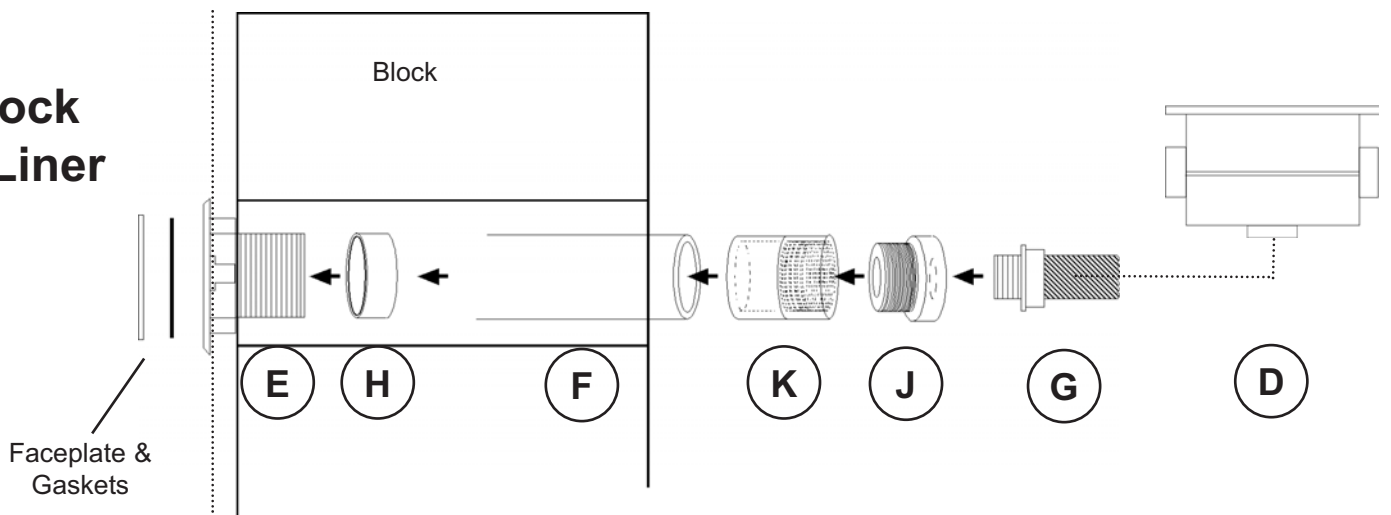

### Concrete Pool

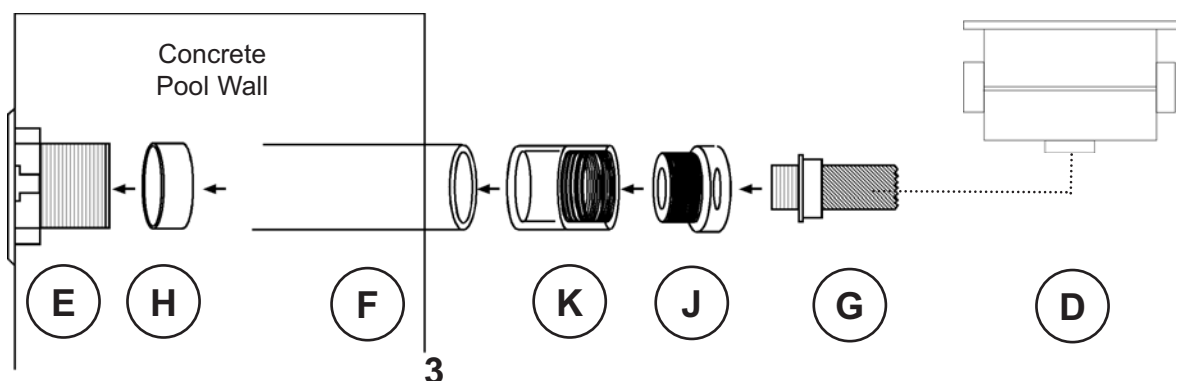

**STEP 3** Remove ' Coverplate (A) from light unit by undoing 3 x cover screws ((L).

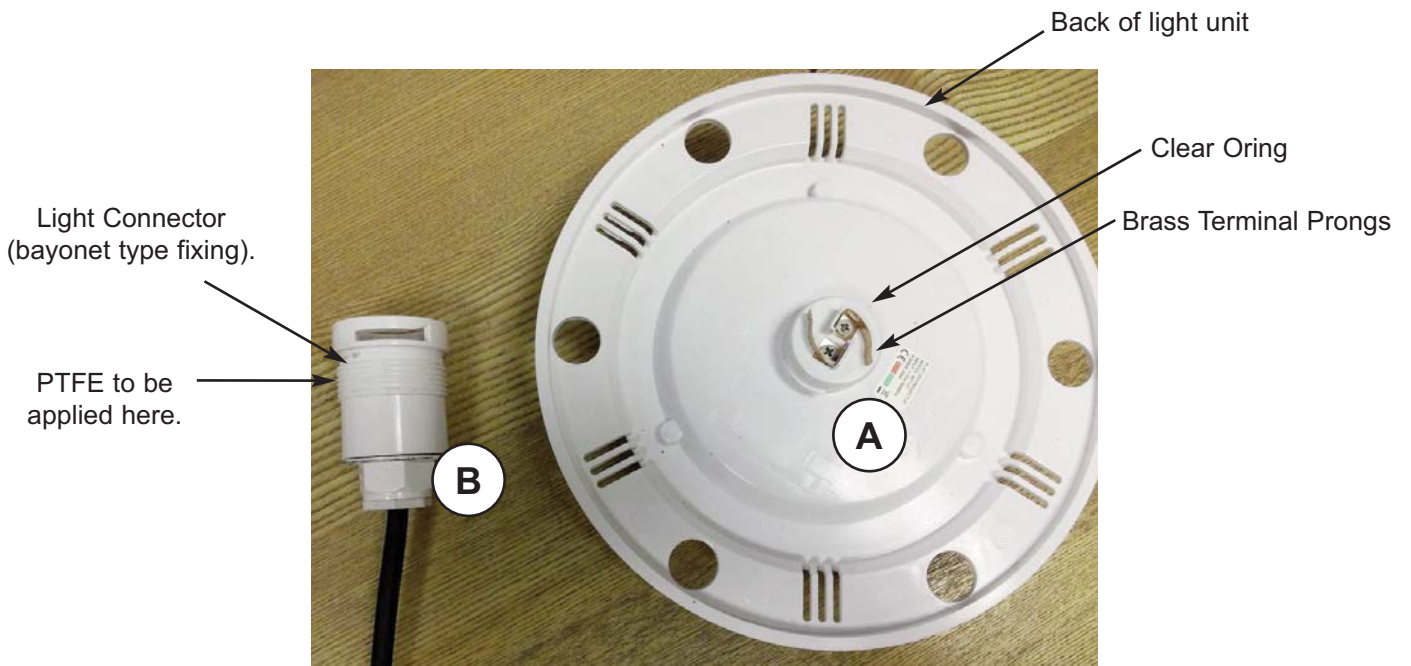
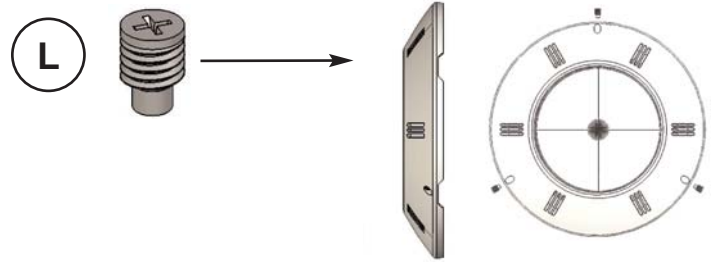

**TIP..** Prior to fitting any RGB colour or 18 / 24W White LED light units (any light with a remote control) into the pool wall fitting, we recommend that you individually test and pair the lighting sequences for each light- see page 6 for instructions.

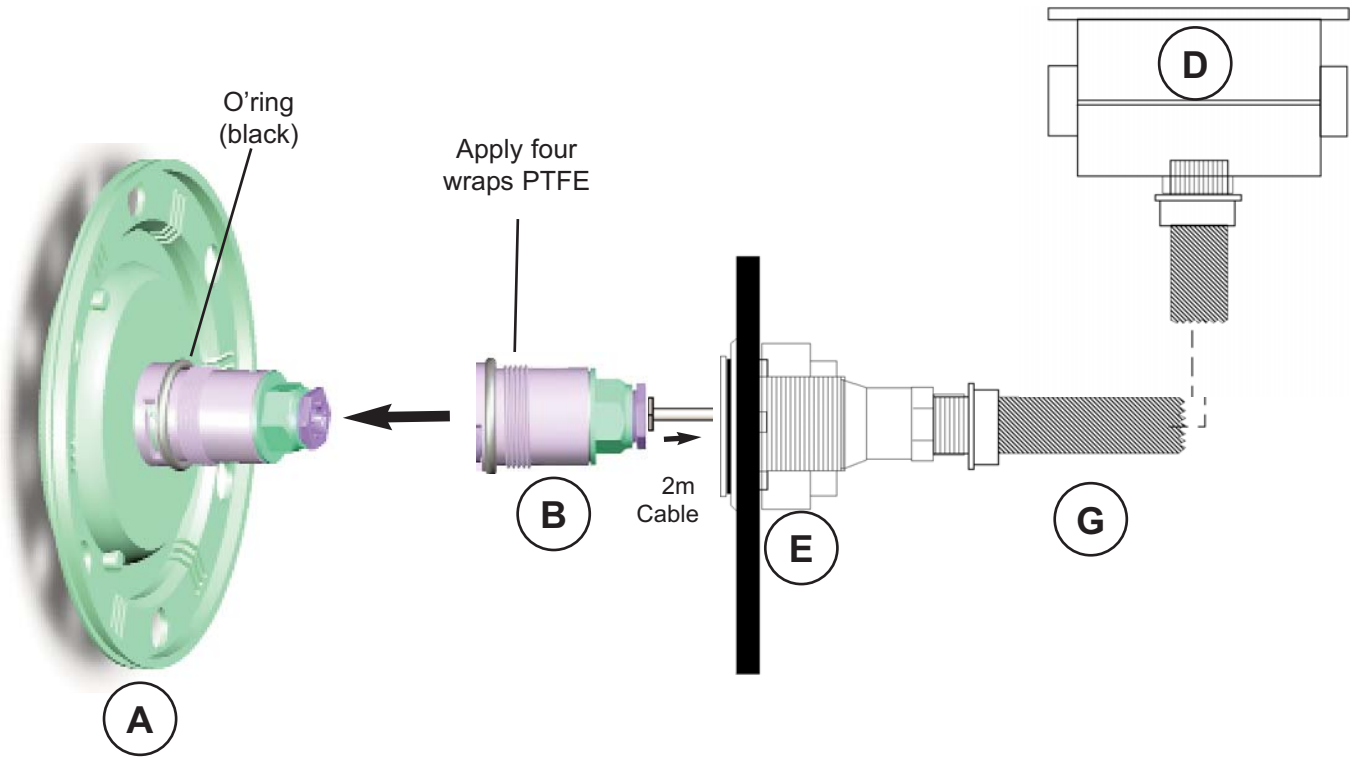

**STEP 4** Thread 2m lighting cable attached to LED light connector unit (B) through Wall Fitting / Conduit / Deck Box (D). Note. Any excess cable can be trimmed or left in wall fitting.

**STEP 5**

1. Lubricate 'clear oring' with water on back of light unit.
2. Attach Light Unit (A) to Light Connector (B) to light unit.

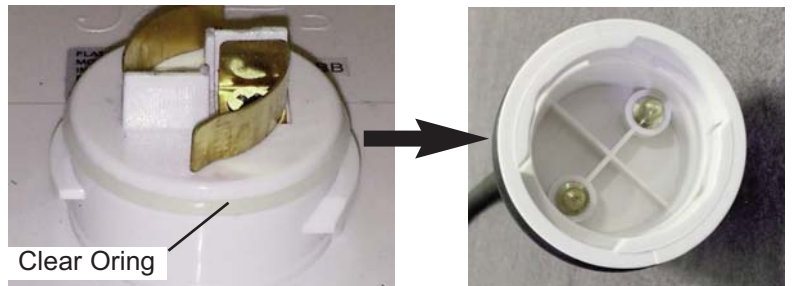

**STEP 6 Important..**apply four wraps PTFE tape to light unit connector (B- bayonet fitting) and attach to main light housing (A) making sure that the clear oring is not pinched.

**STEP 7** Below picture.... Insert (screw) complete light unit (A & B) into wall fitting (E) making sure that the 'black oring' forms a seal against the wall fitting...do not overtighten!

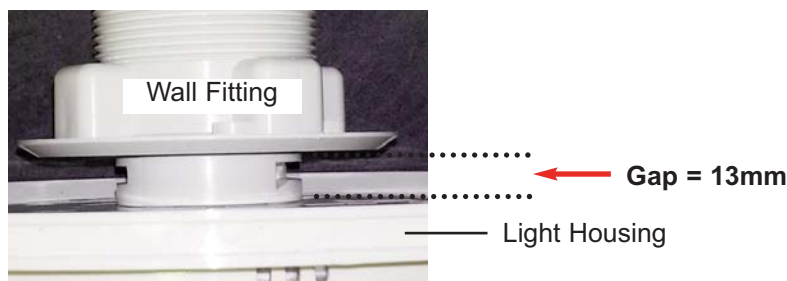

**STEP 8** Apply front cover (A) and secure using 3 x screws (L) that were removed in step 3. **IMPORTANT- do not over tighten cover screws. Coverplate (A) is meant to rotate freely.**

**STEP 9** Have a qualified electrician connect cable to a 12VAC power supply in Deck Box (D). Ensure that the bulb(s) is connected to a transformer of a power at least equivalent to the total of all the bulbs. Electronic or electromagnetic transformers are prohibited. See page 7 for transformer detail.

# LIGHT OPERATION - PAIRING

## RGB - Operation & Pairing.

The RGB LED light - has a manual program with 11 static colours and 5 coloured environments controlled by the provided radio remote controller. The use of the remote controller requires that you must position yourself facing the lamp at a maximum distance of 10 meters (remote control antenna must be fully extended). Any metallic elements that are sited near the LED bulb may interfere with the radio reception and reduce operation down to 1 or 2 meters.

*You may use the main ON/OFF isolation switch to manually change the programs of the light. Switching the ON/OFF button within 2 seconds will change the program. Leaving the light OFF for over 10 seconds and then switching back ON again, restarts the last lighting program (sequence).*

A special remote switch (attached to main transformer) is required for multiple light systems - contact your dealer for details.

### Remote Control pairing process:

Pairing process requires two people. One person should turn the main isolation switch on/off whilst another person faces the light unit with the remote control. Do not try to turn isolation switch on/off by yourself and then run out to pool to press the O & S button...it will not work!

- \* Install the battery in the remote controller
- \* **IMPORTANT...**turn the light unit on/off using the isolation switch in the plant room until the colour changes to lightest blue colour (almost white).

### The following steps should now be taken.

- \* Have someone turn the isolation switch OFF/ON/OFF/ON .. ideally calling out this procedure to the person who has the remote.
- \* When this has been done Immediately, press the buttons O & S together for 2 seconds. Each lamp connected to the transformer should flash once to validate the pairing.
- \* Press **C** (manual selection) or **P** (five automatic lighting sequences) buttons to choose your desired lighting sequence.

Pairing process may take several attempts!

NOTE- the factory setting for the light should default to the lightest blue colour (almost white). If you find that one or two lights have different colours, isolate each light from the transformer and manually change the colour using the on/off switch until all lights are the same colour. Once this has been achieved, one remote should be able to pair and operate all the lights (5 maximum).

## White LED Unit with remote control- 24W system only.

### Remote Control pairing process:

Pairing process requires two people. One person should turn the main isolation switch on/off whilst another person faces the light unit with the remote control. Do not try to turn isolation switch on/off by yourself and then run out to pool to press the O & S button...it will not work!

- \* Install the battery in the remote controller
- \* **IMPORTANT...**turn the light unit on to check that is working then off for a minimum 10 seconds then back on.
- \* Have someone turn the isolation switch OFF/ON/OFF/ON .. ideally calling out this procedure to the person who has the remote. When this has been done Immediately, press the buttons O & S together for 2 seconds. Each lamp connected to the transformer should flash once to validate the pairing.





# TRANSFORMER INSTALLATION GUIDE

## LED 12v Transformer suitable for 1 to 5 Seamaid lights



### Warning



**Persons installing the product must be suitably qualified. All electrical work must conform with the latest BS 7671:2008 IEE Wiring Regulations 17th Edition: SPECIAL WIRING FOR SWIMMING POOLS, Section 702.**

The transformer is a sealed unit and cannot be repaired. Any attempt to open or modify the transformer shall void the guarantee.

This transformer has been manufactured to comply with IEC EN60 742 and BS 3535 and designed to operate with Seamaid SEAFPLWH LED lighting system only. The transformer **is protected by an in-built self resetting thermal cut out**. The transformer has a protection rating of IP65 making it suitable for use outside zones '1' & '2' as specified in the IEE 17th Edition Wiring Regulations, Section 702 for swimming pools.

**GUARANTEE** Failure to comply with the instructions given by the manufacturer in this instruction regarding installation exonerates the manufacturer or the distributor from any liability for damages affecting persons and shall void the guarantee.

The Transformer is a sealed unit and cannot be repaired. Any attempt to open or modify the transformer shall void the guarantee.

The Transformer is guaranteed for 12 months against any materials and/or manufacture defect from the date of delivery. (Please keep the purchase invoice/receipt)

The product is not guaranteed against electrical voltage surge coming from the external power supply. (In this case, refer to the house insurance coverage)

This guarantee is conditioned with the strict respect of these instructions of assembly and maintenance. Under this guarantee, the only obligation falling on the manufacturer or distributor will be the free replacement or repair of the product or the element found defective by their after sale services. All the other expenses will be the responsibility of the purchaser. For any replacement or repair, the product must be subjected to an inspection to the after-sales service of the manufacturer or distributor.

Any defects and deterioration caused by the fair wear and tear or defects resulting from a incorrect assembly or modification (unless by written agreement of the manufacturer) are excluded from guarantee.

The guarantee is limited to the original customer purchaser and is not assignable.

If a defect in materials becomes evident during normal use and service within one year, we will supply a replacement free of charge, within a reasonable time, without transportation costs (limited to United Kingdom). The manufacturer/distributor/retailer will not be liable for consequential damages to your home or other equipment, loss of time, inconvenience or loss of use of the Transformer.

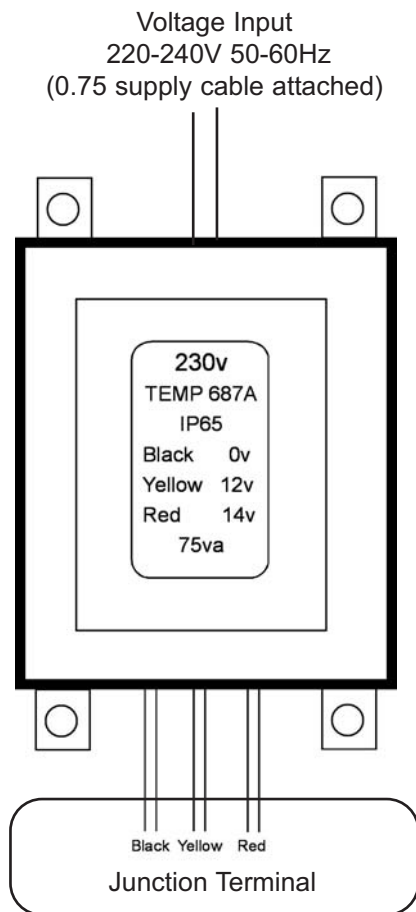

## Installation.

The transformer has been **designed to supply up to a maximum of 5 x 18W or 4 x 24W Seamaid LED lights** and is for wall mounting only.

It is recommended to use 2.5mm SWA cable between the transformer (C) and the deck box (D) up to a maximum distance of 50 metres. There are 3 x 1.5mm output cables (Black, Yellow, Red) attached to the transformer.

The Black cable is COMMON and in most cases used with the Yellow (12v) lead. If long cable runs to deck box(es) (D) result in a voltage drop, it may be necessary to connect to the Red cable (14v). All connections should be made in a suitable terminal box (not provided).

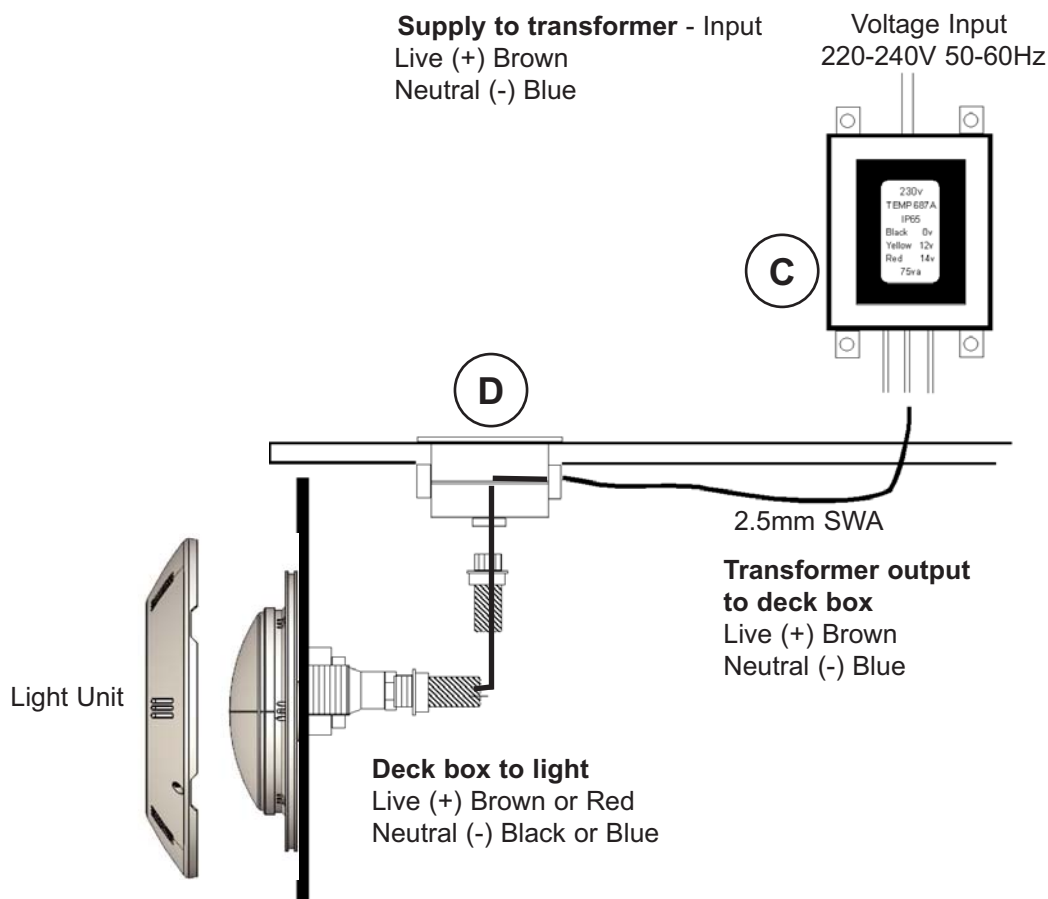



# REPLACEMENT LED Lamp PAR56

12V AC for swimming pools

WHITE /RGB

ROHS REACH  
® International patent



Failure to comply with the instructions given by the manufacturer in this manual regarding installation, operational start up and maintenance of the product exonerates the manufacturer or the distributor from any liability for damages affecting persons, the concerned product or the other installations, and shall void the guarantee.

Installation, repair and maintenance operations must always be carried out with the product disconnected from the electricity supply

The product should not be powered by a voltage of more than 12 Volts

Persons installing the product must be suitably qualified and be familiar with the BS 7671 IEE Wiring Regulations 17th Edition: SPECIAL WIRING FOR SWIMMING POOLS

Conditions of use, storage and shipment :-20°C / + 65°C

It is recommended to install a protection device against excess voltage coming from the main electric supply to prevent irreversible damage to the product.

## INSTALLATION - WHITE / RGB

Seamaid LED PAR56 lamps 12 Volts AC can replace the traditional PAR56 lamp on a new or existing swimming pool. They are not suitable for the Seamaid Flat Universal one-piece modular light system.

Bulbs are available in WHITE or RGB with a Remote Control Unit.

### Installation Guide

Change the existing o'ring gasket when replacing a bulb on an old light system. Do not install a replacement bulb if original housing has been distorted due to overheating.

Ensure the bulb(s) are connected to a transformer of a power at least equivalent to the total of all the bulbs. The use of electronic or electromagnetic transformers are prohibited. To synchronise RGB bulbs they must be connected to the same transformer. Handle the lamps with care on a clean towel.

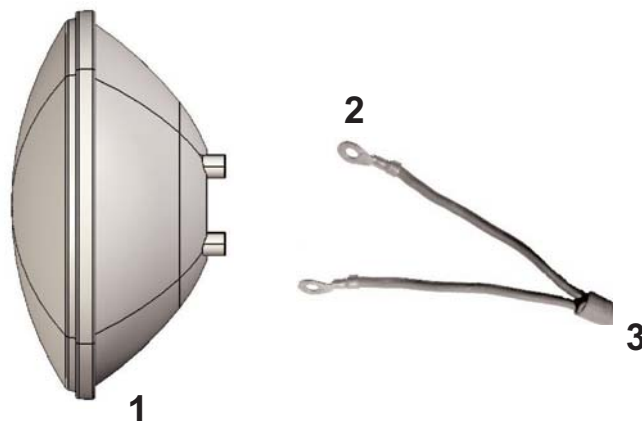

1. Before any installation/replacement; turn off power supply to bulb.
2. EXISTING POOLS (Non Seamaid ) Remove existing light from housing as per the manufacturers instruction (providing enough cable (3) has been provided) and place onto pool surround. If no excess cable has been left, lower pool water to gain access from within the pool.
3. Access light housing to remove existing bulb as per manufacturers instruction.
4. Remove the spade connectors (2) from the back of bulb terminal (1).
5. Remove any visible scale deposit from wire electrical spade connectors (2) using an abrasive paper (wet 'n' dry) and check connections are secure.
6. Check and change if necessary the o'ring seal. Use a silicone sealant for added precaution.
7. If bulb housing is distorted, do not install bulb. A replacement bulb housing will need to be purchased.
8. Re-insert the light system back into light housing.
9. Turn on power supply. Light is now ready to use. See operation instructions on page 10.

# OPERATING INSTRUCTION - Replacement LED Bulbs

## RGB - Operation & Pairing.

The RGB LED light - has a manual program with 11 static colours and 5 coloured environments controlled by the provided radio remote controller. The use of the remote controller requires that you must position yourself facing the lamp at a maximum distance of 10 meters (remote control antenna must be fully extended).

*You may use the main ON/OFF isolation switch to manually change the programs of the light. Switching the ON/OFF button within 2 seconds will change the program. Leaving the light OFF for over 10 seconds and then switching back ON again, restarts the last lighting program (sequence).*

A special remote switch (attached to main transformer) is required for multiple light systems - contact your dealer for details.

### Remote Control pairing process:

Pairing process requires two people. One person should turn the main isolation switch on/off whilst another person faces the light unit with the remote control. Do not try to turn isolation switch on/off by yourself and then run out to pool to press the O & S button...it will not work!

- \* Install the battery in the remote controller
- \* IMPORTANT...turn the light unit on/off using the isolation switch in the plant room until the colour changes to lightest blue colour (almost white).

### The following steps should now be taken.

- \* Have someone turn the isolation switch OFF/ON/OFF/ON .. ideally calling out this procedure to the person who has the remote.
- \* When this has been done Immediately, press the buttons O & S together for 2 seconds. Each lamp connected to the transformer should flash once to validate the pairing.
- \* Press **C** (manual selection) or **P** (five automatic lighting sequences) buttons to choose your desired lighting sequence.

Pairing process may take several attempts!

NOTE- the factory setting for the light should default to the lightest blue colour (almost white). If you find that one or two lights have different colours, isolate each light from the transformer and manually change the colour using the on/off switch until all lights are the same colour. Once this has been achieved, one remote should be able to pair and operate all the lights (5 maximum).

### RGB - Remote Control



- O** - On/off
- S** - Synchronising Function
- C** - Colours 1-11
- P** - Programme 1-5

\* Supplied with MN23 type 12v alkaline batteries

## White LED Unit with remote control- 24W system only.

### Remote Control pairing process:

Pairing process requires two people. One person should turn the main isolation switch on/off whilst another person faces the light unit with the remote control. Do not try to turn isolation switch on/off by yourself and then run out to pool to press the O & S button...it will not work!

- \* Install the battery in the remote controller
- \* IMPORTANT...turn the light unit on to check that is working then off for a minimum 10 seconds then back on.
- \* Have someone turn the isolation switch OFF/ON/OFF/ON .. ideally calling out this procedure to the person who has the remote. When this has been done Immediately, press the buttons O & S together for 2 seconds. Each lamp connected to the transformer should flash once to validate the pairing.





## RGB Above Ground Pool Light (with remote control) UK - INSTALLATION GUIDE

### Warning



Failure to comply with the instructions given by the manufacturer in this manual regarding installation, operational start up and maintenance of the product exonerates the manufacturer or the distributor from any liability for damages affecting persons, the concerned product or the other installations, and shall void the guarantee.

Installation, repair and maintenance operations must always be carried out with the product disconnected from the electricity supply

The product should not be powered by a voltage of more than 12 Volts

Persons installing the product must be suitably qualified and be familiar with the BS 7671:2008 IEE Wiring Regulations 17th Edition: SPECIAL WIRING FOR SWIMMING POOLS

Conditions of use, storage and shipment :-20°C / + 65°C

It is recommended to install a protection device against excess voltage coming from the main electric supply to prevent irreversible damage to the product..

**GUARANTEE** This LED bulb is guaranteed 24 months against any materials and/or manufacture defect (electronic components) from the date of delivery. (Please keep the purchase invoice/receipt)

The bulb is not guaranteed against problems coming from excessive voltage, electrical overload, electric short-circuit or excessive over tightening of light housing.

The product is not guaranteed against electrical voltage surge coming from the external power supply. (In this case, refer to the house insurance coverage)

This guarantee is conditioned with the strict respect of these instructions of assembly and maintenance. Under this guarantee, the only obligation falling on the manufacturer or distributor will be the free replacement or repair of the product or the element found defective by their after sale services. All the other expenses will be the responsibility of the purchaser. For any replacement or repair, the product must be subjected to an inspection to the after-sales service of the manufacturer or distributor.

Any defects and deterioration caused by the fair wear and tear or defects resulting from a incorrect assembly or modification (unless by written agreement of the manufacturer) are excluded from guarantee.

The guarantee is limited to the original customer purchaser and is not assignable.

If a defect in materials becomes evident during normal use and service within two years, we will supply replacement parts free of charge, within a reasonable time, without transportation costs (limited to United Kingdom). The manufacturer/distributor/retailer will not be liable for consequential damages to your home or other equipment, loss of time, inconvenience or loss of use of the LED light.

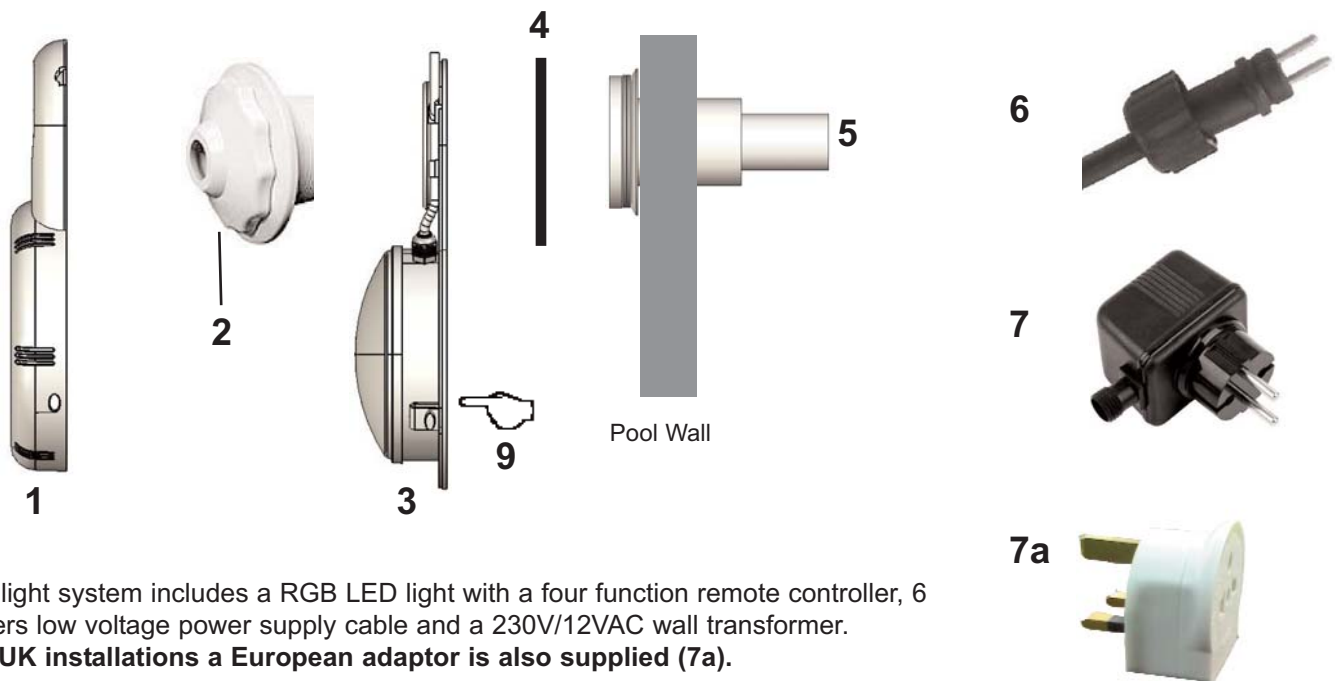

The light system includes a RGB LED light with a four function remote controller, 6 meters low voltage power supply cable and a 230V/12VAC wall transformer.

**For UK installations a European adaptor is also supplied (7a).**

This lighting system has been designed to be installed in an above ground pool by attaching the light unit onto the outlet fitting (2). There are many different types of outlet fittings and in most cases the light housing is compatible. In the event that your outlet fitting is not compatible an alternative replacement may be required, please contact your dealer.

Before installing light ensure the above ground pool is provided with a compatible outlet fitting (hole diameter of light fitting is 60mm). Do not install in a flexible PVC walled pool. The transformer (7) is connected to an electrical supply and must be installed a minimum distance of 3.5 meters from the pool. Do not touch the plug with any part of the body if wet. Ensure nobody stands in the pool during installation. After each use, disconnect the wall transformer from the main voltage supply.

**In the event that the 6m cable supply needs to be extended this must be carried out by an electrician who is suitably qualified and be familiar with the BS 7671 IEE Wiring Regulations 17th Edition & SPECIAL WIRING FOR SWIMMING POOLS**

### Installation

- " Remove the front cover (1) by pressing with fingers on the 2 clips (9)
- " Unscrew the outlet fitting (2) - FRONT PART ONLY and remove it from the wall inlet (5)
- " Install the back support (3) adjusting the top hole on the wall inlet
- " Replace the outlet fitting (2) and hand tighten against the pool wall. (In certain case you can use the black gasket (4) behind the support (3) and the wall fitting to guarantee the lighting cannot move after tightening)
- " Replace the front cover (1) by adjusting first the top hook and then press on the 2 clips to guide it to a correct position
- " Connect the cable to the wall transformer (7) by inserting into the plug (6). If possible place the cable under the top rail.
- " Connect the transformer to the main power, the LED bulb lights on first program (white)
- " Proceed to pairing operation below

**Operation** - You are able to programme 11 static colours and 5 colour environments controlled by both the provided radio remote controller (8) and a manual ON/OFF switch.

The use of the remote controller requires that you must position yourself facing the lamp at a maximum distance of 10 meters (remote control antenna must be fully extended). Any metallic elements that are sited near the LED bulb may interfere with the radio reception and reduce operation down to 1 or 2 meters. You may use the main ON/OFF switch to change the programs of the light.

Switching the ON/OFF button within 2 seconds will change the program. Leaving the light OFF for over 10 seconds and then switching back ON again, restarts the last lighting program (sequence).

### Remote Control pairing process:

- \* Install the battery in the remote controller
- \* Switch OFF/ON/OFF/ON the power supply of the lamp(s)
- \* Press the buttons **O** & **S** together during 1 second
- \* Each lamp connected flash once on white colour to valid the pairing

Press several times the button **C** (manual selection) or **P** (five automatic lighting sequences).

